

SMARTUNERS[®]

for **Stealth Antennas**

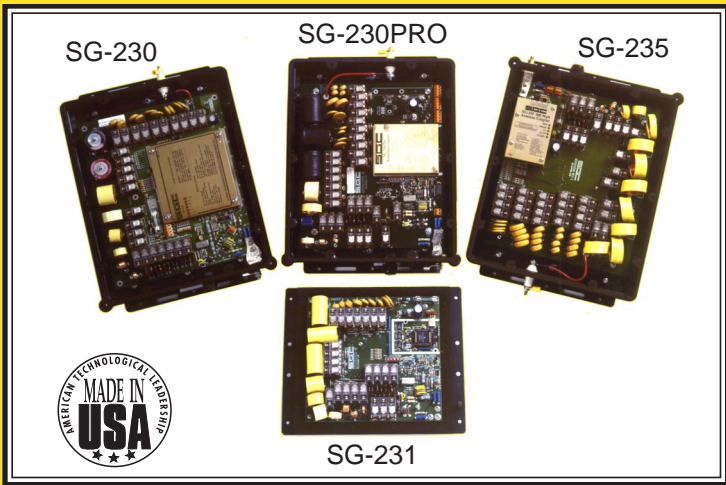

SGC[®]

"No Compromise Communications"

Smartuners for Stealth Antennas



“No Compromise Communications”

Table of Contents

Introduction	1
Chapter 1 Tuner, Coupler, What is the Difference?	2
Chapter 2 Why an Antenna Coupler?	4
Chapter 3 Basic Antenna Theory	6
Long Antenna	
Short Antenna	
Antenna Radiation Patterns	
Antenna Height and Radiation Angle	
Chapter 4 Antenna Types - Theory	10
Vertical	
End Fed Wire, or Marconi	
Inverted L	
Center Fed	
Loop	
Chapter 5 Practical Installations	14
Ground Systems	
Flag Pole Vertical	
Tree Mounted Verticle	
Invisible L	
Where is the Loop?	
Center Fed Stealth Antenna	
Tree Supported Delta Loop	
Chapter 6 Indoor Antennas	22
Indoor Loops	
Apartment Loop	
Portable Loaded Loop	
Attic Antennas	
Chapter 7 Construction Techniques	25
Wire Antennas	
Weather mounting the SGC Smartuners	
Chapter 8 Conclusion	27
Glossary	28

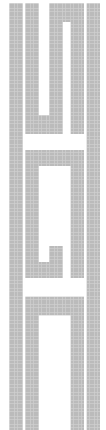

Introduction

Using the SGC Smartuners® in Antenna Restricted Locations

The purpose of this book is to assist those who must operate a High Frequency radio station from an antenna restricted environment. You will find that it is not necessary to install large obtrusive antenna systems to have effective HF communications. Of course the information contained here can be applied to non restricted environments as well. Even if you are not an experienced radio operator, you will find plenty of information to install an effective HF antenna system in any location or environment.

If you already have a working knowledge of HF antenna systems, we hope that this information will spark your interest in experimenting with different designs to optimize the performance of your installation. Using the SGC Smartuners® removes most of the tedious impedance matching circuit design and construction from your antenna experiments, and allows you to spend your time more effectively in trying different ideas and getting signal measurements and reports.

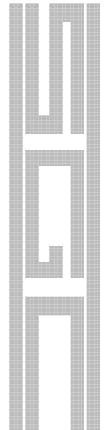

Chapter 1

Tuner, Coupler, What is the Difference?

Antenna couplers are placed at the antenna, and precisely match conditions of the antenna to the feed line. Antenna tuners are generally located at the transmitter output, at the radio end of the coaxial feed line. A tuner placed at the transmitter, fools a transmitter into working correctly. A coupler installed at the antenna feed point eliminates the most serious cause of feed line losses by providing a proper match of the antenna to the feed line. The Smartuner® is a true antenna coupler.

*typical antenna tuners do not have the wide impedance matching range that the SGC couplers offer.

The SGC Smartuner® series of automatic antenna couplers eliminates these challenges, and allows a single antenna to operate efficiently at any frequency in the HF and even VHF to 60 MHz. bands. Tuning is completely automatic, and very fast. The weather proof design allows mounting the Smartuner® at the antenna feed point, so the feed line (coax cable) always has a low SWR, and low loss.

Smartuner® Family

SG-230

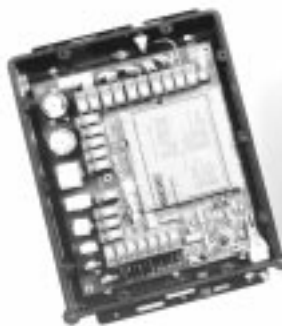

SG-230PRO



SG-235



SG-231

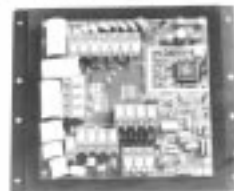

The SGC Smartuners® are general purpose antenna couplers which can be operated with any HF radio and almost any type of antenna configuration. The coupler network consists of a π (pi) or L type. It automatically selects appropriate algorithms that have been determined from the internal coupler measurements. It reads, and feeds this information back to the microprocessor. The initial (first time) tuning may take one to several seconds depending on the complexity of the tuning process for the particular antenna. After tuning the first time for a specific frequency and antenna, this information is entered in the non-volatile computer memory which will store up to 500 tuning solutions. When the same conditions are encountered again, re-tuning is accomplished within 10 milliseconds by recalling the information from the memory. Special software has been designed by SGC to allow accurate and fine tuning of the coupler.

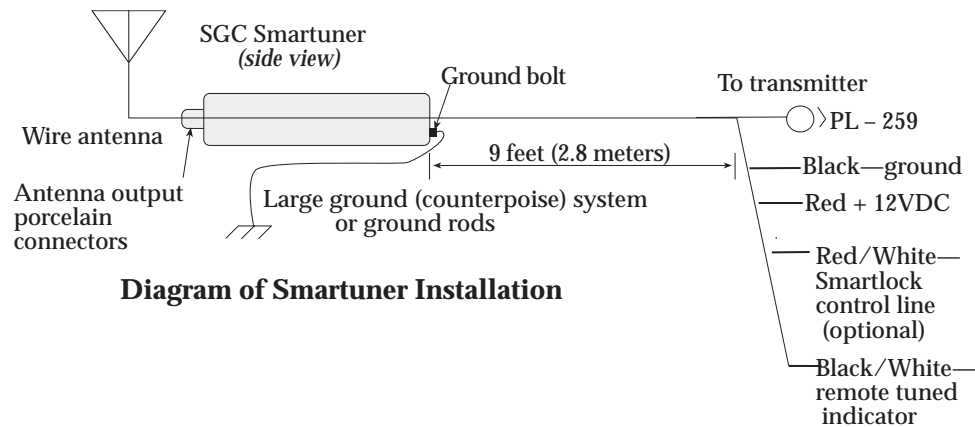

The matching range of the Smartuner® is much greater than the conventional manual tuner, and offers much greater flexibility. Yes, it can probably tune up the proverbial “wet string” (make sure that you use salt in the water)!
 *most other couplers on the market do not have this tune from memory feature, and must retune each time that the frequency is changed.

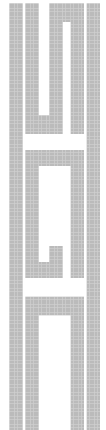

Chapter 2

Why an antenna coupler?

The antennas outlined in this book are fed with an SGC Smartuner®. This offers many advantages over conventional antenna feed methods. Virtually all modern transmitters are designed to operate into a 50 ohm load. If the antenna presents some other value, the transmitter will not be able to deliver full power to the antenna, and may even shut down completely or be damaged by an improper load.

Some antennas by design, will offer close to the desired 50 Ohm load on the design frequency. The common dipole is a good example. The feed point impedance of the perfect dipole in free space is about 72 Ohms, and in a real installation may be closer to 50 Ohms. Such an antenna can be operated very efficiently without a tuner, and fed with coax cable, but only on the band for which it is designed.

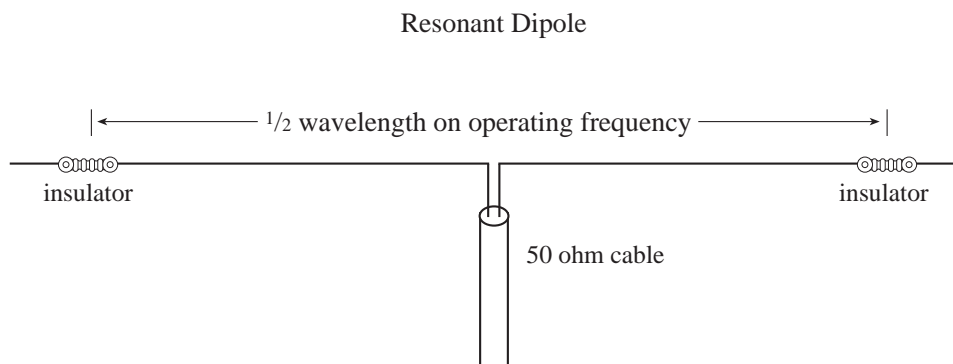

One solution to this challenge is to provide one antenna for each band of operation. This might be a good solution if you only work on one or two bands, but is very difficult or impossible to do from many restricted locations. Some specially designed antennas such as trapped antennas can operate on more than one band, and offer some solution to the frequency agility problem. The downside is that traps are often inefficient, and you are stuck with the design length and installation restrictions of the particular antenna.

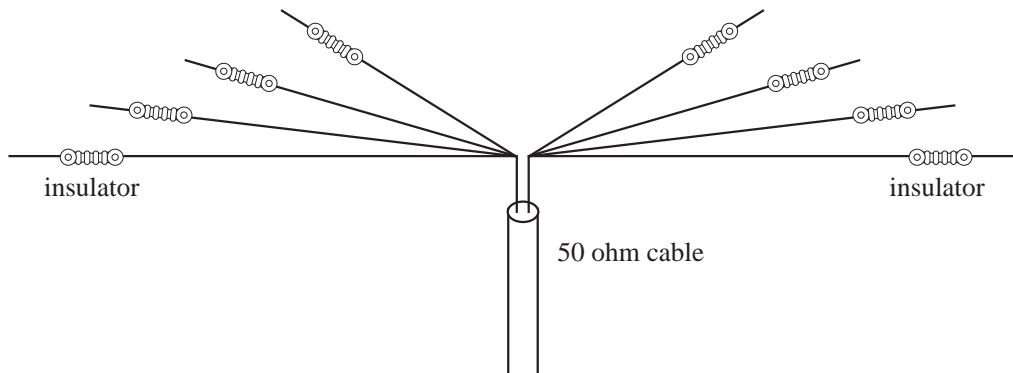

Cat Whisker Antenna

Four dipole antennas fed with a single feed line provides four band coverage but is not well suited to restricted environments.

It is possible to extend the coverage of a dipole or other type of antenna by installing a conventional manual tuner in the feed line, but efficiency falls off rapidly as the SWR on the feed line increases. This type of installation may allow for effective operation across one band, and even good operation on the third harmonic, but will provide *poor results at some other frequencies*. This is not to say that the tuner cannot provide a 50 Ohm load to the transmitter; it probably will; the trouble is that the feed line will be operating at a very high SWR, and system loss will be unacceptable.

An antenna such as a dipole can be fed with open wire or ladder line similar to the familiar 300 Ohm TV antenna lead in wire with good efficiency, as the feed line loss is less at high SWR. Still, you must manually tune the system each time that you change bands. This type of feed line must be routed away from conductive objects, and cannot be buried.

4 Bands with 1 antenna

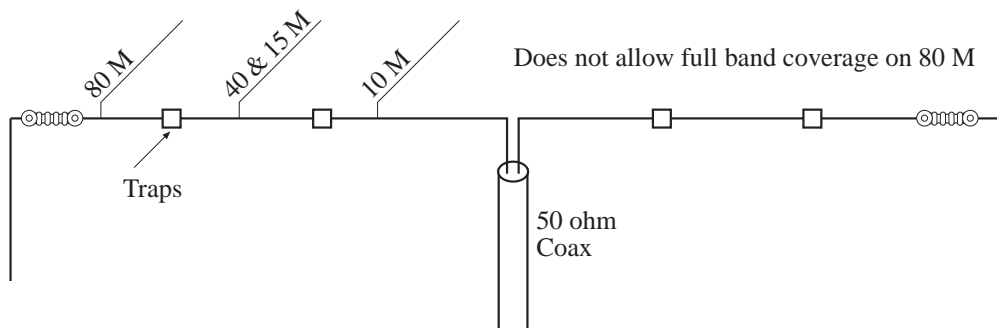

Trap Antenna

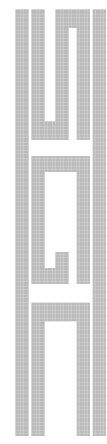

Chapter 3

Basic Antenna Theory and Facts.

It is the job of the antenna to radiate the electrical energy from your transmitter as electromagnetic radio wave. It is important to remember that even the best antenna coupler cannot perform well without a good antenna. It is the job of the Smartuner® to match the antenna to the transmitter. It is the job of the antenna to radiate the energy.

Almost any conductive object can be made to radiate some electromagnetic energy, some will do so far more effectively than others. While it is true that the SGC Smartuner® will match the load of an 8 ft. antenna to your transmitter at 1.8 MHz., the efficiency of the antenna will be very poor. How poor? Consider this example:

Long Antenna

Frequency = 1.8 MHz. Antenna: Dipole, Length: 240 ft. efficiency: nearly 100% effective radiated power with 100 watt transmitter: 90 watts. This means that all but about 10 watts from the transmitter is being radiated by the antenna. Now take a look at what happens with a very short antenna.

Short Antenna

Frequency = 1.8 MHz. Antenna: Steel whip Length 8 ft. Efficiency: about 2% Effective radiated power with 100 watt transmitter: About 2 watts!

As you can see, there is more to the antenna question than just getting the antenna 'tuned'. Very short antennas will not work efficiently on the lower bands. Of course this is an extreme and somewhat simplified example, and electrically short antennas can provide useful radiation. Just keep in mind as you select the antenna for your location, that it is usually best to use the largest radiator that your installation will accommodate.

Antenna Radiation Patterns:

Along with efficient operation of an antenna, it is also a good practice to design for the desired radiation pattern.

This is a complex subject when working with frequency agile antenna systems, as the characteristics of a given antenna are dependent on its frequency of operation.

For example:

The classic dipole antenna is said to have strongest radiation broadside to the wire, and a slight null off the ends. This is true only when the following conditions are met.

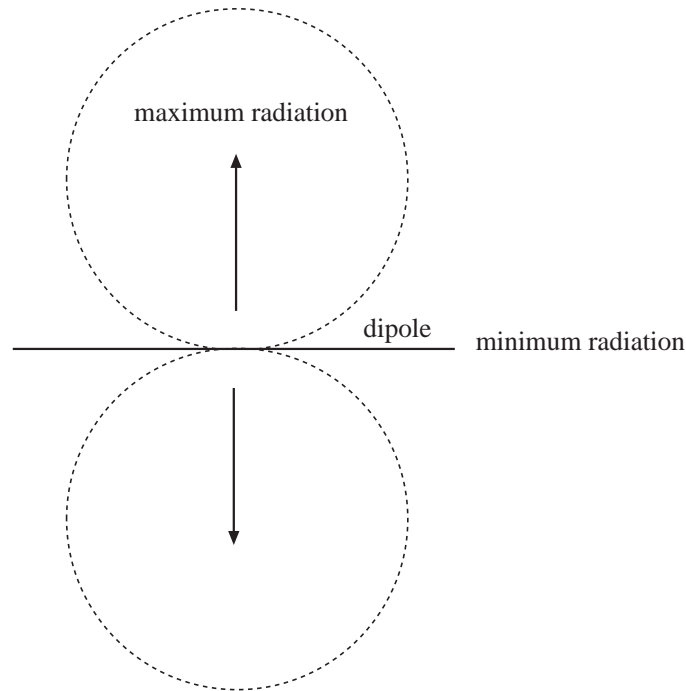

Dipole Radiation Pattern Antenna

The antenna is 1/2 wavelength above ground. For example, a dipole for the forty meter band would require a height of 20 meters.

Antennas closer to the ground will tend to be more omni directional.

The antenna is operated on the design frequency. The antennas that we will be discussing will be for operation across the HF spectrum. The radiation pattern will be different on each frequency!

The antenna is in the clear, without obstruction from nearby conductive objects. Most antennas that are installed in a restrictive environment will be affected by nearby house wiring, power lines, and other objects. This will distort the natural radiation pattern of a given antenna.

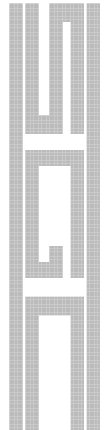

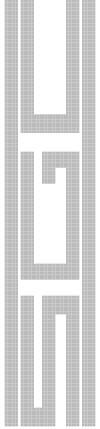

Very long wires will exhibit a different radiation pattern. Wires that are more than a few wavelengths long will exhibit some directivity near the end of the wire. This can be true even if the wire is close to earth.

An example of this situation would be a 200 ft. wire operating on the 10 meter band. This antenna would be fairly directive off the ends of the wire, and would have a null off the sides. This could be a real advantage if it is considered in the design and orientation of the antenna.

Very Long Antenna

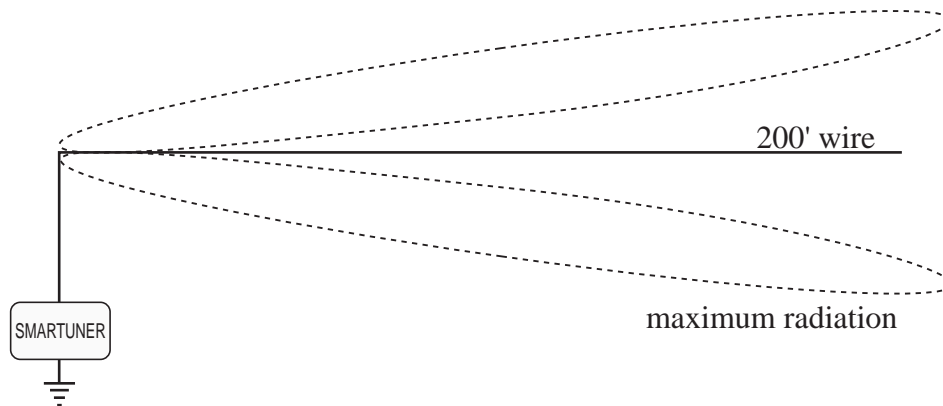

The end result of the above factors is that radiation patterns for your antenna may be predicted only in a general way, and will be different on each band.

It is possible to design your antenna for a desired radiation pattern on a particular band, or perhaps even 2 bands if you like. Additional information is available in the ARRL Antenna Handbook. There are also antenna modeling programs available for your PC that will allow you to analyze different antenna types. However, antennas described in this book will offer effective communications in almost all situations. You should keep in mind that it may be better to design for highest efficiency than for any specific radiation pattern.

Antenna Height and Radiation Angle

Antenna height above ground has a lot to do with the way an antenna will perform. It may or may not be worth extra time and effort to get the antenna high above the ground. This depends upon the coverage that you need. If you are interested in working stations out to about 500 miles on the 40 and

80 meter bands, a horizontal antenna that is relatively close to the ground will give good results. This is due to the fact that most of the radiation will be at high angles, and the strongest refraction will return to earth nearby. This is called NVIS for near vertical incident skywave. NVIS antennas are popular for emergency communications groups needing only regional coverage. These expressions are somewhat simplified for convenience, and if you wish to expand your knowledge about antenna height and radiation angles, we suggest that you study the ARRL antenna book, and perhaps investigate the antenna modeling software referred to elsewhere in this book.

If you want to chase DX, you will need to get the antenna about 1/2 wavelength or more above ground at the operating frequency. On 20 meters and above, this is not a major challenge as it requires that the antenna be only 10 meters above ground. Most of us will not be able to get this height for the low bands, 40 meters and down, and a vertical antenna may be the better choice. The vertical will not be as strong as a horizontal antenna until the distance is over about 1,000 miles, then the vertical antenna with its lower angle of radiation will be the winner.

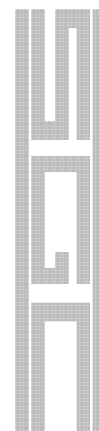

Chapter 4

Antenna Types:

We will take a brief look at some popular types of HF antennas, and their suitability for restricted environment applications.

Vertical Antenna

The vertical antenna can be a good choice for small lots, and if disguised as a flag pole, can provide an effective antenna that is completely invisible! The radiating element must be isolated from ground. One method used to accomplish this is to use rigid plastic pipe for the pole, and run a heavy gauge wire inside the pipe.

For a more robust installation, a fiberglass or delrin rod that fits the inside diameter of an aluminum pole can be used as a base insulator. Fiberglass or delrin stock is available from industrial supply houses.

Commercial fiberglass whip antennas are available from marine supply stores. These are designed to be installed on boats, but can give good service on fixed stations as well. They are available in lengths from 17 ft. to 26 ft. It is possible to paint the antenna to camouflage it, and such an antenna could be used very effectively in some antenna restricted environments.

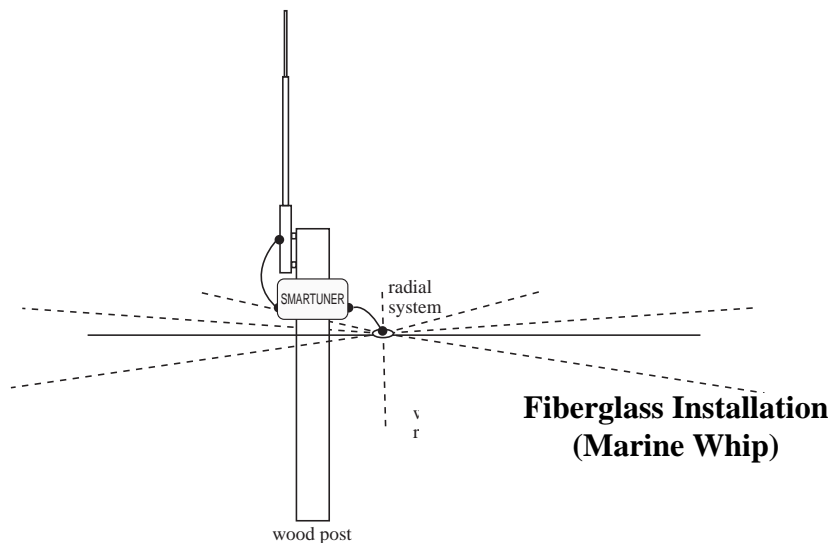

This installation provides operation from 1.6 to 30 Mhz

Suitable vertical radiators can also be constructed using aluminum or steel mast that is commonly sold for supporting television antennas. Remember that most vertical antennas must be insulated from the earth at the base. One simple method we have used, is a thick glass bottle buried at the base of the antenna. The neck of the bottle fits inside the mast, and insulates it from ground. Of course such an insulator offers no lateral support, and can only be used with antennas that are supported by guy wires, or attached to some supporting structure, such as the eaves of a building.

In these installations, the Smartuner® is located at the base of the antenna. Don't forget to provide protection from direct sunlight load.

End Fed Wire, or Marconi Antenna

One of the most simple types of antenna is the end fed wire. This antenna is fed with the SGC Smartuner® at or near ground level. It can be nothing more sophisticated than an odd length of wire with the far end supported by some convenient structure, such as a tree or pole. There is no magic length, or optimum length, unless you decide to optimize the design for operation on your favorite band as discussed earlier.

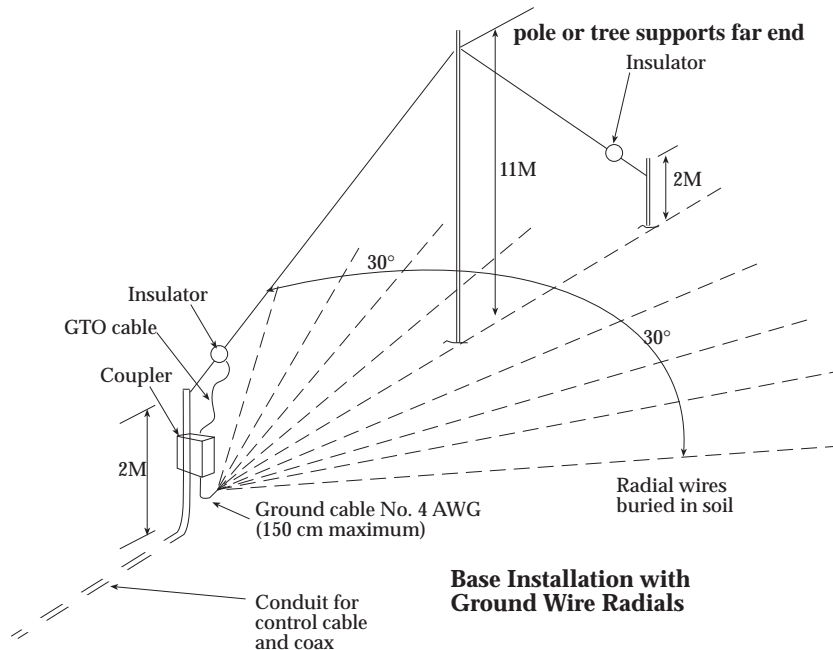

This antenna should be made as long as possible for best efficiency. It will provide omni directional coverage if it is installed near vertical, and will provide low angle radiation good for working DX.

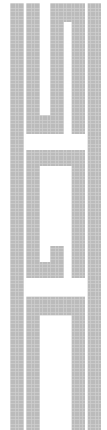

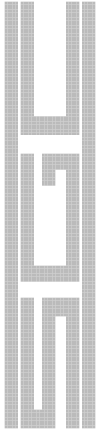

This antenna requires an effective earth ground or counterpoise, as described later in this book, and may not be a good choice for installation above ground, such as a second floor apartment.

Inverted L Antenna

The Inverted L is a popular low band antenna, and is suitable for installation in restricted areas. This antenna will provide excellent performance and good low angle radiation for working DX, as well as some high angle horizontally polarized radiation that is good for working nearby stations. The vertical portion of the antenna should be as long as possible, with the horizontal length supported by a tree, building, or pole. If you can get over 100 ft. total length, you will have very efficient 160 meter band operation, and good operation on the higher bands as well. The overall effectiveness of this antenna will be determined by the length of the radiating element, and the quality of the ground or counterpoise system.

The entire antenna can be made from wire if you have the supports. A more popular method is to use an aluminum mast for the vertical section, and wire for the horizontal portion. The base of the antenna must be insulated from ground, and a suitable ground or counterpoise system used.

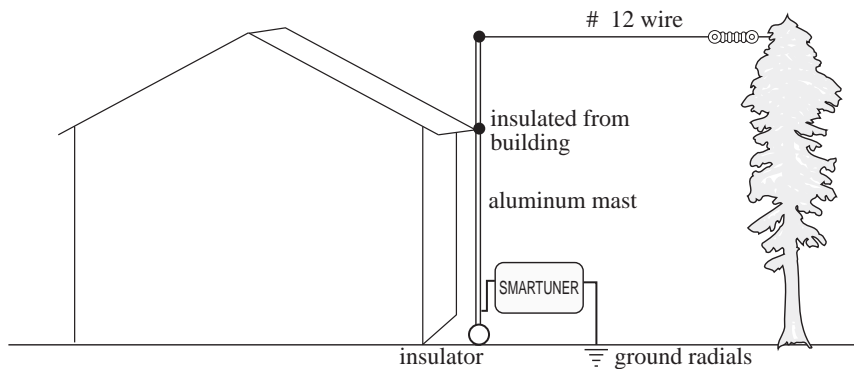

Center Fed Antenna

The center fed antenna can be a very effective radiator. It does not require an earth or counterpoise connection. This type of antenna is often installed in a horizontal plane, as high above the earth as possible.

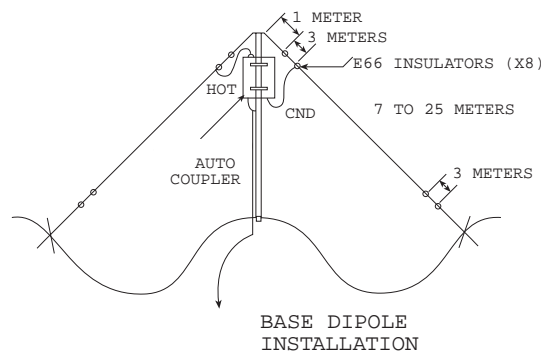

There is no reason why you cannot install the center fed antenna with the ends bent or zig zagged to fit your location, and it is certainly better to use this method of installation than to shorten the antenna to fit.

You can also let the ends of the antenna drop towards the ground with very little effect on efficiency.

The SGC Smartuners can be located on the antenna supporting structure, whether it is a tower, flag pole, chimney or whatever. We do suggest that the unit be shielded from direct sunlight and possibly large hail stones. (See illustration on page 26)

Loop Antennas

The term loop antenna is used to describe an antenna that is closed at the ends. Popular shapes are squares, rectangles, and deltas (triangles). The larger the enclosed area of a loop antenna for a given length of conductor, the higher the efficiency of the antenna will be.

Loop antennas may be oriented either vertically, or horizontally, and even at an angle in between. The loop can be fed at any point on it's parameter.

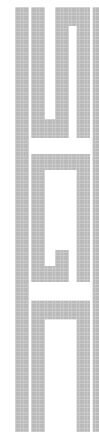
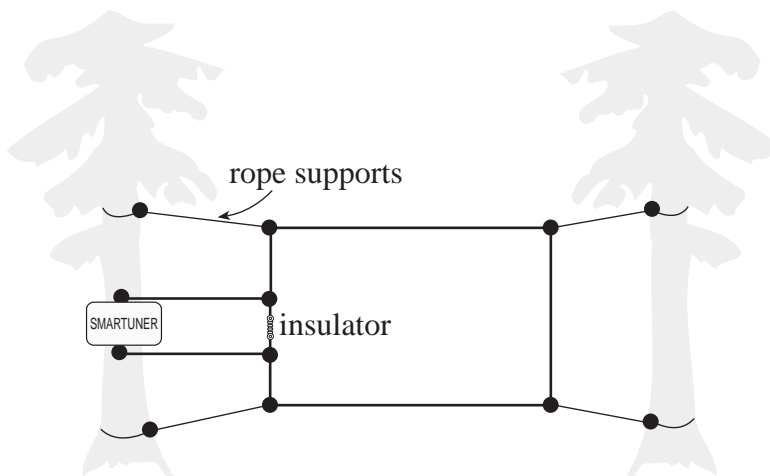
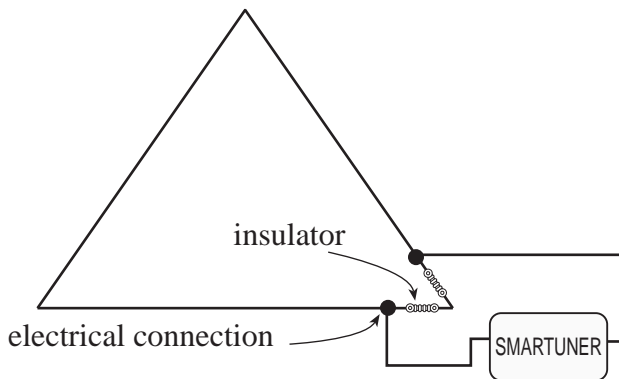

Chapter 5

Practical Installations

At SGC, we get calls everyday, asking if the Smartuner will tune a particular type of antenna. The impedance matching range of the Smartuners is from about .1 Ohm to 10,000 Ohms. As long as you follow the basic guidelines and use good practice, you can expect the Smartuner to match virtually any load to your transmitter.

Ground Systems

If you use a center fed, or loop antenna, it is not necessary to install a ground or counterpoise system.

If however you are using any type of end fed antenna, the radio ground, or counterpoise will be a primary factor in how well the system performs. While it is true that the SGC Smartuners® will load up an end fed wire against a single 8 ft. copper ground rod, this is far from the ideal situation. It is very important to recognize that as in any electric circuit, there must be a return path to complete the circuit. In the case of the vertical, or end fed antenna, this path consists of the earth ground, or the counterpoise system. Volumes of information have been published on this subject. We will offer here, a few tried and true solutions that will be helpful in many cases. Possibly the most important consideration is the location of the ground or counterpoise system. It is of the utmost importance that the Smartuner® be located within no more than three feet of this point! Closer is better. There are no exceptions to this rule. The reason is that any significant length of conductor will present high impedance to RF energy at some frequencies. A long path to ground will look like an open circuit on some frequencies! Plan for this in advance, and you will have an antenna system that operates well on the first try.

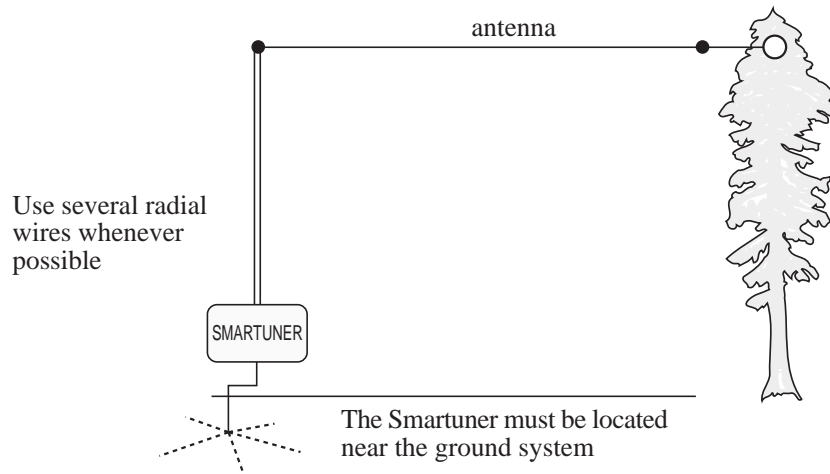

If you cannot locate the Smartuner® in a position that allows a short connection to the ground or counterpoise, you would do well to consider a center fed antenna, or loop.

The most desirable setup will be a counterpoise made up of four or more radial wires, each about 1/3 longer than the radiating element. These wires can be above ground, or buried a few inches in the earth. It is advisable to use insulated wire for the radials to slow the corrosion process. You may increase the number of radials if you have the space and resources to do so, and enjoy increased performance from your system.

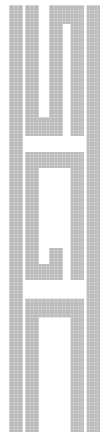
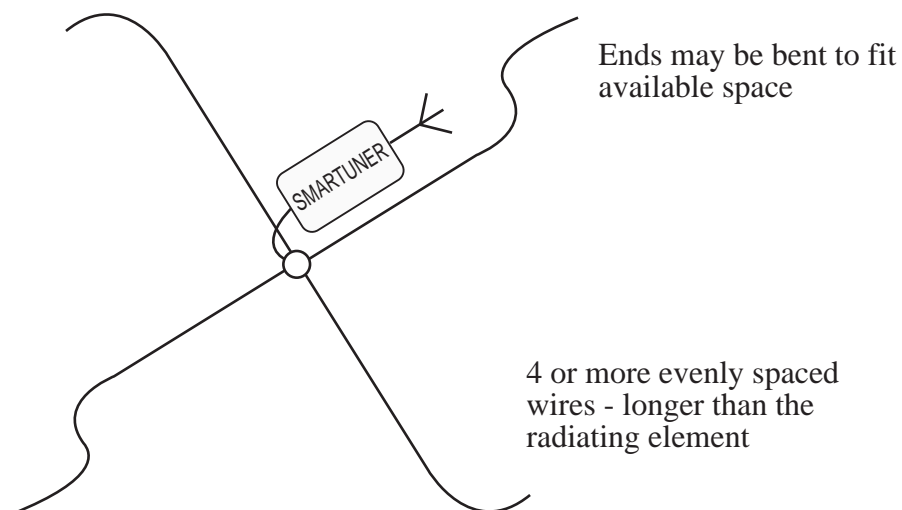

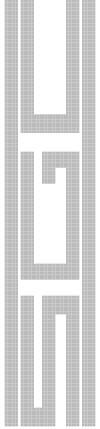

The radials may be bent and zig zagged to fit your lot, but they should not cross each other. You can use less than four radials if you are willing to sacrifice some performance. Keep in mind that the AM broadcasters use a radial system with 120 wires!

If you have no room to install a radial counterpoise system, you may choose to use an earth ground instead. With this type of system, multiple rods will be driven into the earth at the ground point. Again, you must locate the Smartuner® within a few feet of the earth ground! No exceptions.

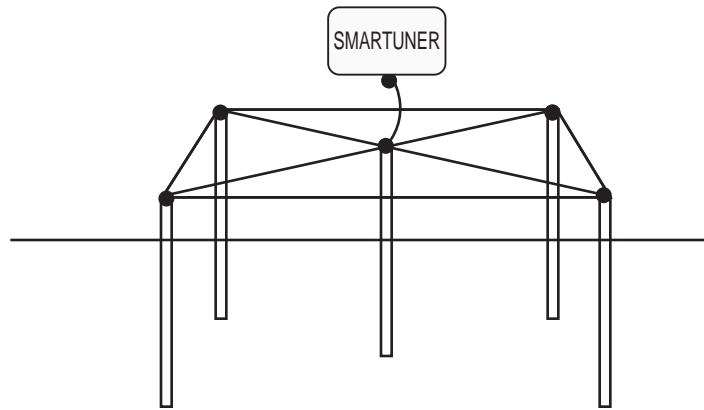

Use 8 ft. copper plated steel rods. These may be purchased at a hardware or electrical supply house. Four rods in a square, and about 5 ft. apart is suggested. The rods should be driven into the ground until only a few inches remains above the earth. The rods are then connected together with 3/4 inch braid or copper flashing. Use the same type of conductor to make the connection to the ground lug on the Smartuner®. All ground connections should be soldered to maintain a good connection over time.

In some instances you may be able to use existing plumbing as a ground system. If your building has copper pipe for the water system, it may be possible to connect to it for a ground system. The results will vary depending on many factors, but be aware that such a ground may be “polluted” from the nearby AC mains, and can pick up noise from nearby electronic devices. It is always better to provide an isolated ground system when possible.

Another, possibly better source of a good ground system is a copper piped sprinkler system.

Last and probably least desirable, you may consider the installation of a counterpoise made up of a length of wire somewhat longer than the radiating element that is bent to fit your installation. Such an installation may be useful if you must use an end fed antenna from a second story (or higher) location.

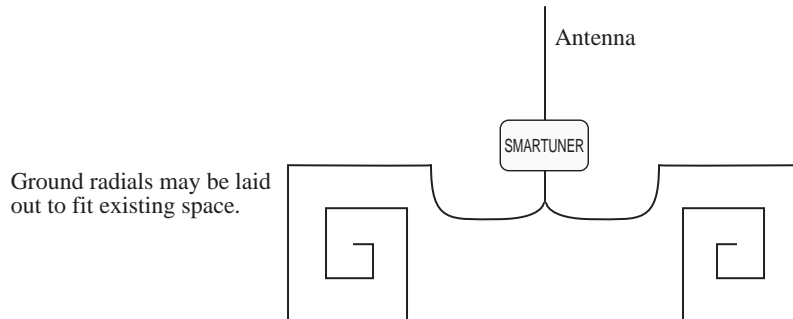

We have seen some degree of success with this type of counterpoise when it is looped around the interior floor of the operating room. Keep in mind when considering this type of installation, that the possibility for interference both to and from nearby electronic devices is high, and that the strong RF field around the transceiver can cause trouble with the radio itself during transmit.

As you can see, the vertical or end fed wire may not be the simple solution that it first seems to be. If you do not have the space or ability to provide an adequate ground or counterpoise system, perhaps a center fed or loop antenna will be better suited to your installation.

Now that we have a little background theory, lets look at some specific installation ideas.

Flag Pole Vertical

In a neighborhood that allows no antennas at all, this is a solution worth considering! You may choose to construct the pole from plastic pipe, aluminum or some other metal. If you are using a commercially made metal flag pole, you must either insulate the base of the pole from the earth, or use the shunt feed method.

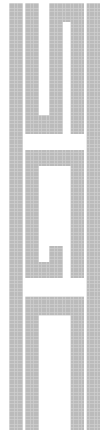

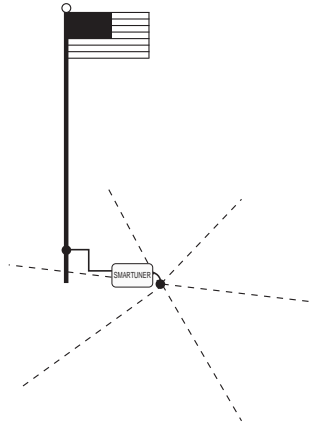
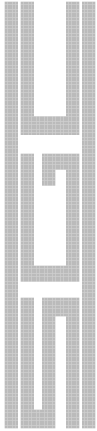

This type of pole may be insulated by cutting a section off of the bottom end, and inserting a fiberglass or delrin rod that fits the inside diameter of the pole. This rod should be several feet long to distribute the load, and may be secured to the pole by drilling through the rod and pole and using 1/4 inch bolts.

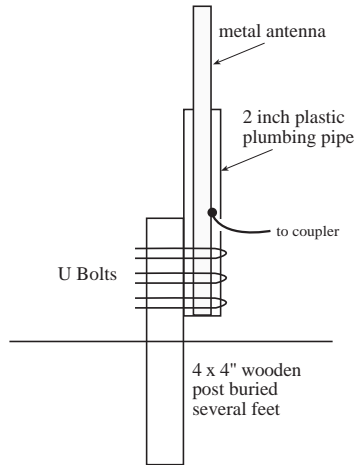

Close-up Fibreglass or Delrin Rod

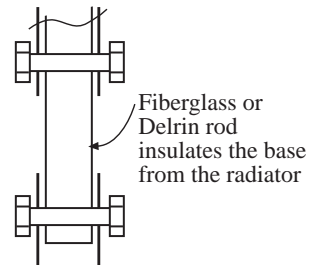

Use any plastic insulator to mount mast. One very convenient method is to use plastic plumbing pipe.

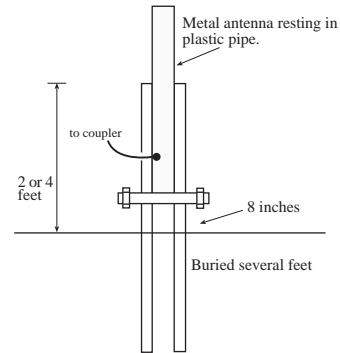

The shunt feed method does not require that the pole be insulated from ground, and the shunt feed wire may be disguised as part of the rigging.

The feed wire should be connected to the pole near the top. Stand offs hold the feed wire at least 12 inches away from the pole. The base of the pole is connected to the ground system along with the Smartuner® ground connection.

If you use plastic pipe, you will need to install a conductor inside. A #6 wire will do nicely. The Smartuner® must be located at the base of the pole, where it will connect to the ground system. You may choose either the buried radial system, or the ground rod system that are described elsewhere in this book.

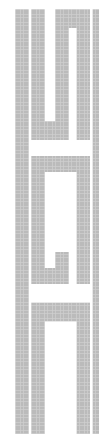

Tree Mounted Vertical

A tall tree can be used to support a vertical antenna with good results. The radiating element can be made of wire, or metal tubing such as copper pipe. The element should be insulated if it can come in contact with wet leaves or branches.

The Smartuner® should be located at the base of the tree, and the ground system can be either ground rods or radials as discussed in the section on grounding.

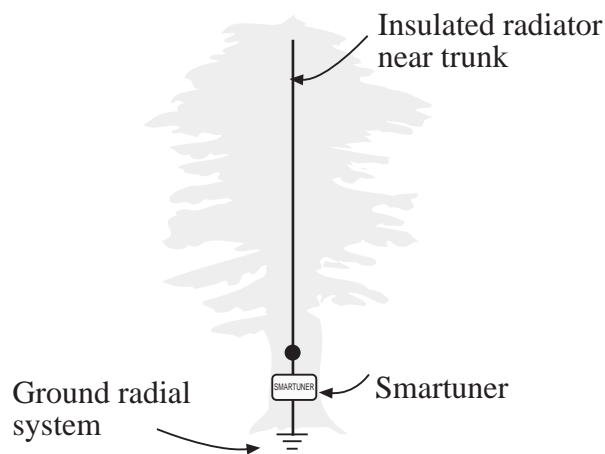

Invisible L

Another antenna that can be made virtually undetectable is the inverted L. The vertical portion of the radiator is near the building wall, and can be painted to match. The horizontal section lies on or near the non metallic roof. It is best to make the antenna as long as possible to get good efficiency on the lower bands.

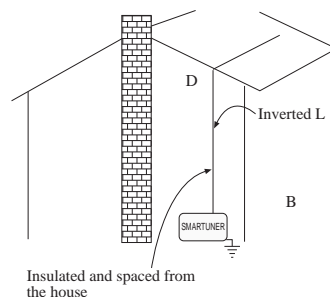
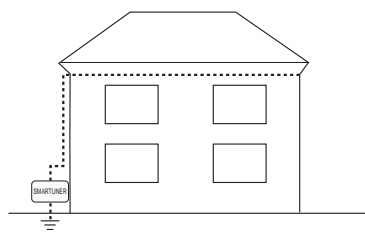

B
Always use ground radials when possible. Avoid ground rods as they may not work well.

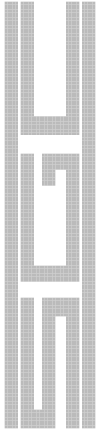

Where is the loop?

A horizontal loop can be supported under the eaves of the building. Inexpensive insulators purchased from a radio supply store are used to keep the radiating element from touching the building.

The antenna need not be symmetrical for the loop to give a good account of itself. The Smartuner[®] is inserted into the loop at any convenient point.

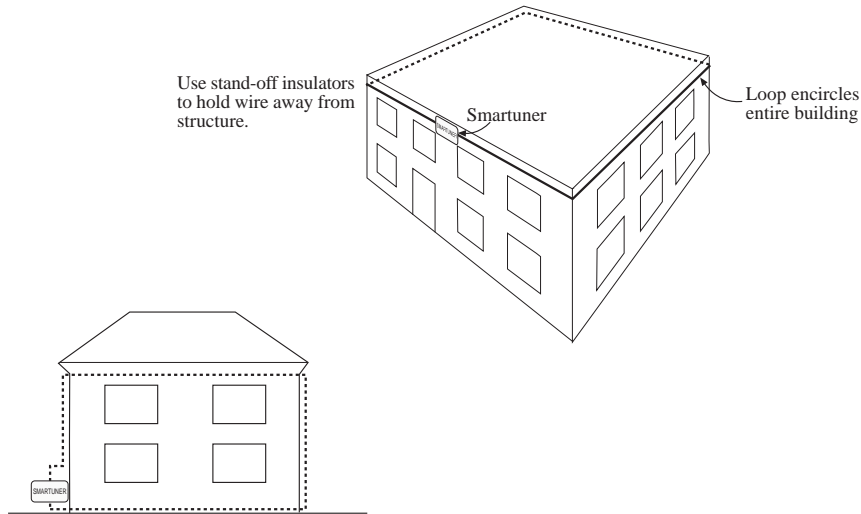

Center fed Stealth Antenna

This is one idea for a center fed antenna that can be installed under the eaves of a building.

Remember that it is OK to bend the elements of a center fed antenna, and that it is better to use this method than to shorten the elements just to keep them straight.

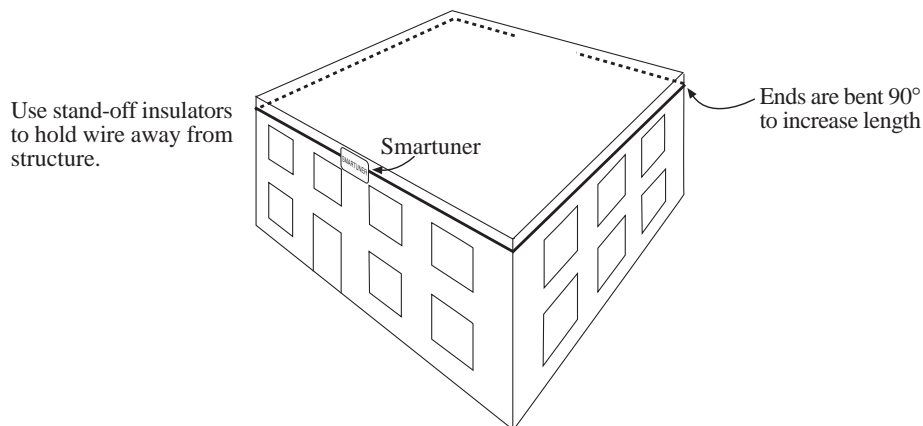

Tree Supported Delta Loop

Trees have long been used for antenna supports, and here is a method that allows installation of a delta loop antenna that requires only a single support. In this case, a tree.

The lowest part of the antenna should be several feet above the ground for best results. The Smartuner® is usually inserted at a bottom corner of the loop, but good results can be achieved by feeding the antenna at the bottom center, or even at the top.

The delta loop is supported from the tree top and ground posts with a dacron rope.

No ground system is required within the loop antenna

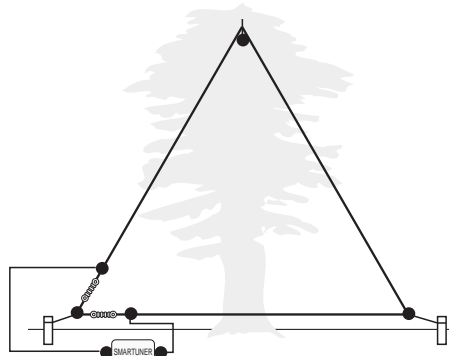

Detailed View

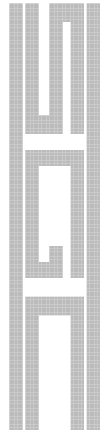
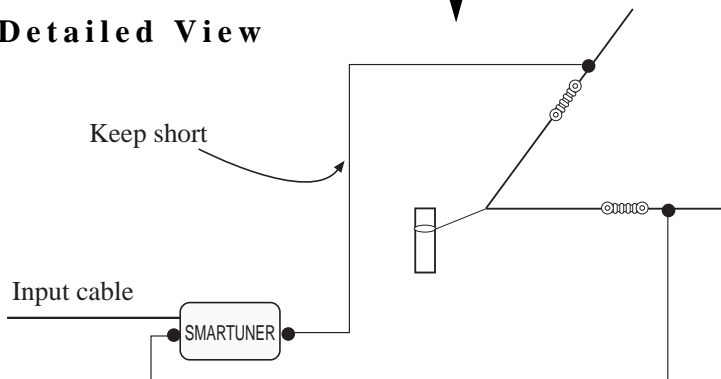

Chapter 6

Indoor Antennas

There may be some environments where the dreaded “antenna police” are so astute that you dare not put any antenna outdoors. It is possible in such instances to get on the air with an indoor antenna. Do not expect that any indoor antenna system will offer the same performance as a good outdoor system, and make sure that you have exhausted all other possibilities before you decide that you must use an indoor antenna. When using an indoor system, locate all parts of the antenna system as far away as possible from potential sources of interference. These will include just about anything that uses electricity, but most commonly, fluorescent lamps, computers, transformers, AC wiring, etc. Loop antennas may offer some relief to the indoor antenna interference problem, but all of the configurations mentioned previously will work indoors.

Indoor Loops

Apartment Loop Antenna

Loop antennas can be used very effectively in small apartments, offices and holding rooms. Radiation from a loop antenna can be very efficient. This antenna consists of several turns of insulated high voltage wire wound close spaced on insulated pegs fastened to an interior wall of the building. Antennas as small as 4 ft. on a side will work, but there is some advantage in using the available wall space by making the antenna larger. Use about 70 - 90 feet of #16 or larger wire with no spacing between the windings.

The transmitting efficiency of a small loop can be quite good, but there will be a sharp null in the plane of the loop. For this reason, you may wish to install 2 antennas at right angles to each other for good coverage in all directions. You will need some provisions to connect only the appropriate antenna.

This loop, and larger ones can be mounted horizontally, and offer good performance for regional coverage on the lower bands, but will probably be a poor performer above forty meters due to the high angle of radiation.

Loop antennas are less prone to pick up man made local noise, and offer some advantage in RF polluted environments. Still, it is very important to locate the antenna as far as possible from sources of radio noise, such as fluorescent lamps, computers, and other electrical devices. Small loops such as this can be installed in a manner that allows them to be rotated. This advantage can be used to reduce reception of local interference, or to optimize reception from a particular direction.

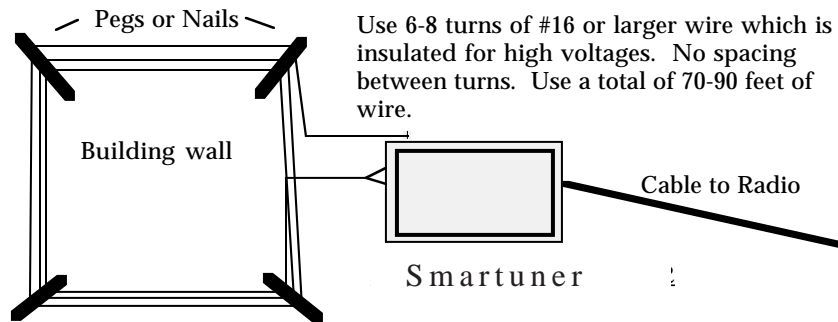

Portable Loaded Loop

This antenna operates in a similar fashion to the above drawing, but uses a helical winding to gain electrical length, and is constructed on a PVC pipe frame.

The first step is to construct a square frame from PVC pipe. Use 1 inch or larger pipe with elbows at each corner. This material is available at any building supply house, and is very inexpensive. It should be at least 4 ft. on each side, but can be made larger with good effect.

If you want the antenna to be free standing, construction should be done as shown in the drawing below.

You may leave off the lower supports and suspend the antenna from the ceiling with a non conductive rope or string if desired.

Keep in mind that the small loop will have a sharp null in the plane of the

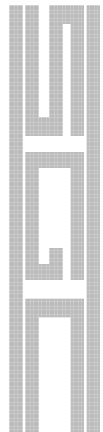
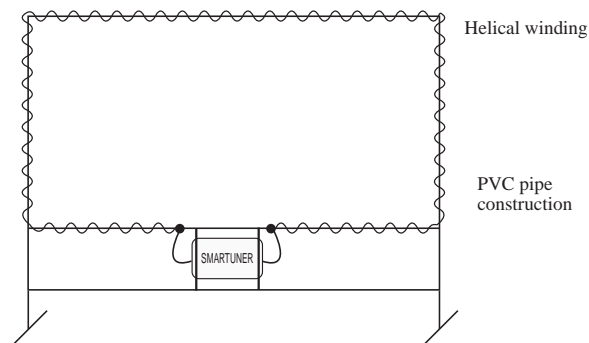

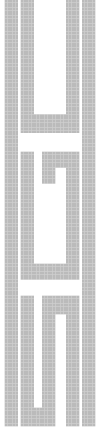

loop, this can be used to reduce interference from local sources by “aiming” the antenna towards the source. It could also reduce the strength of the desired signal if not oriented favorably.

Wind about 70 ft. to 90 ft. of #14 or larger wire in a helical fashion around the pipe. Some experimentation may be required to achieve even spacing of the winding around the loop. The windings can be secured to the frame with electrical tape, hot glue, or some other suitable method.

The Smartuner® can be fastened to the base of the support as shown, and connected to the ends of the windings as shown in the drawing. One end of the winding is connected to the antenna terminal of the Smartuner®, and the other end is connected to the ground lug of the Smartuner®.

Attic Antennas

Much has been written about installing wire antennas in the attic of buildings, mostly by people who never looked up there! The typical attic may be the worst possible RF environment there is! They are full of AC wiring for the lights, often with fluorescent fixtures, metal heater and air conditioner ducting, telephone wiring and so on. If you must use this space for your antenna, any of the loop and center fed antennas previously described can be installed in the attic. End fed antennas are not practical for attic installation, due to the lack of earth ground.

(NOTE: Do not install an antenna in your attic if you have a metal roof.)

Construction Techniques

Wire Antennas

You can use just about any type of conductor to build your antenna, but some will give better service and performance than others. Wire antennas can be constructed with bare or insulated wire. Stranded copper wire is probably the best choice for most installations.

Larger diameter wire will offer less resistance, and slightly better efficiency. In any case, make sure that the wire is of suitable diameter to support its own weight in windy conditions, and use the largest wire diameter that is practical for your application.

All connections must be mechanically secure, and soldered to maintain good electrical performance.

The ends of the antenna must be insulated from the supporting structure. We often use rope to hold the end of an antenna up, and secure it to its support. Dacron rope is one of the better types, and holds up to the elements better than cotton and some other types. Rope will become conductive when it is wet, or even damp. Insulators must be used in all cases. These can be purchased from an electronics supply store. Keep the radiating element a few feet away from the supports.

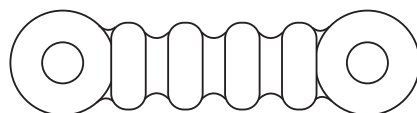

Dogbone Insulator

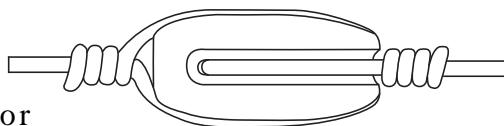

Egg Insulator

When using trees for antenna supports, you must account for the fact that the tree will move in the wind. If the antenna is simply secured to the tree, it is very likely that the wire will be broken the first time that the tree sways in the wind. The solution is to provide a pulley and weight system (as shown in figure on following page) to hold the antenna taught, and allow for movement of the tree in the wind.

Don't forget to put some holes in the bucket so that it does not fill up with rain



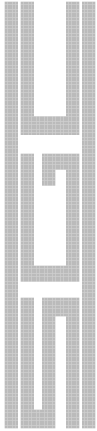

water. Put just enough weight in the bucket to hold the antenna line taut. You can use a slingshot, or bow and arrow to launch a line up and over a tree branch. Be careful what is on the other side! Monofilament fishing line makes a good leader, and small fishing weights can be used with the slingshot. If you

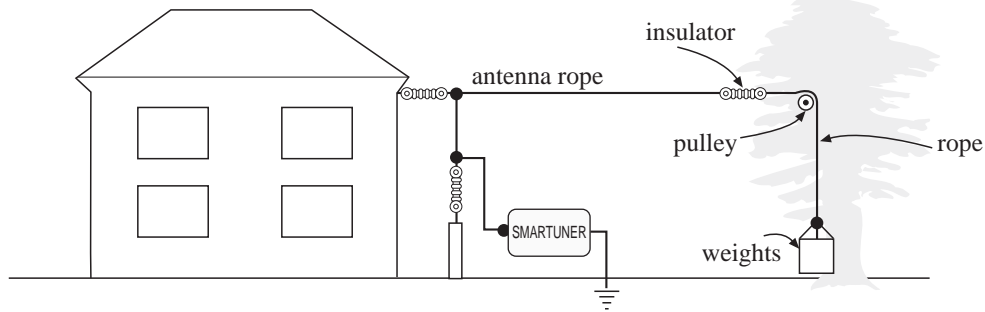

have a bow, consider using a “game finder” device that attaches a special reel of string to the bow, which attaches to the arrow. The idea was to allow you to find your arrow, and the game, but in this case you will use the line to pull up your antenna support rope.

Weather mounting the SGC Smartuners®

Regardless of the installation that you use, it is important to remember a few points about weather extremes and protection from sun, rain, hail, snow and ice of your Smartuner®. The effect of direct sunlight on the case of the Smartuner® (called sun loading) can cause internal temperature to rise as high as 200 degrees F. This is beyond the maximum temperature rating.

The solution is to provide an artificial shade for the unit. One example of how this can be done is shown below.

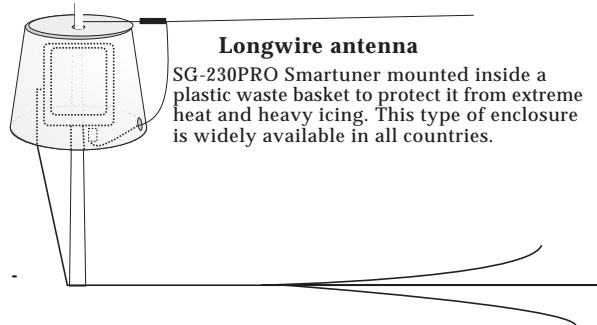

Longwire antenna

SG-230PRO Smartuner mounted inside a plastic waste basket to protect it from extreme heat and heavy icing. This type of enclosure is widely available in all countries.

If the Smartuner® is located under an eaves, or some other shading structure, then no additional steps are necessary.

It is also important to provide strain relief for the antenna and ground connections from the Smartuner®. Your Smartuner® is extremely rugged, but the antenna connections were not designed to support the antenna load. Make sure that the antenna is self supporting before you make the Smartuner® connections, and do not allow the weight of the antenna to pull against the Smartuner®.

Conclusion

So there you have it. We hope that you have learned a little, and that your imagination has been sparked. We have covered only a little antenna design and theory; much more information is available in publications such as the ARRL Antenna Handbook. This volume is published by the American Radio Relay League in Newington Connecticut, and is available through Ham Radio suppliers.

If you have an interesting design or installation that you would like to share, drop us a line. Drawings or photos are very helpful as well.

The complete line of SGC Smartuners® is available from most Ham Radio supply stores. If you need help finding a dealer, or need help with your installation, please feel free to contact us.

We are aware that the cost of the Smartuner® represents a significant expense, but suggest that the overall benefits of the product make it a very attractive solution for your HF antenna system. When you consider the expense involved in putting up an antenna farm to cover the entire HF spectrum, you will soon realize that the SGC Smartuner® is a real bargain.

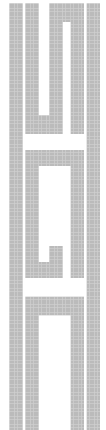

Glossary

10-meters: 28.0-29.7MHz
15-meters: 21.0-21.450MHz
20-meters: 14.0-14.350MHz
40-meters: 7MHz to 7.3MHz
80-meters: 3.5-4.0MHz
160-meters: 1.8-2.0MHz

(+): Positive (power supply input).
(-): Negative (power supply input).

A3A: Mode of single sideband with -16dB pilot carrier.
A3H: AME or AM compatible (carrier with only upper sideband).
A3J: Telephony; single sideband with suppressed carrier.
AGC: Automatic gain control which prevents receiver overload.
ALC: Automatic loading control which prevents transmitter over load.
AMP: Amplifier.
AMTOR: Amateur radio equivalent of SITOR with slightly different standards
ATTN: Attenuator which reduces a received signal.
ADSP: Adaptive Digital Signal Processing; exclusive to SGC, a DSP technology which processes the signal to eliminate unwanted noise and improve incoming signal.
AM: Amplitude modulation, low efficiency type of radio transmission. generally used for broadcast AM radio station bands with 100% carrier inserted.
AMVER: Coast Guard operated system for rescue "automated mutual assistance vessel rescue system."
AM BROADCAST BAND: A band ranging from 530 to 1605 KHz.
AMATEUR BANDS: Frequency bands set aside for amateur radio operators.
AMPLITUDE: The height of a radio or sound wave—loudness.
AMPLITUDE MODULATION: Adding information to an RF carrier by increasing and decreasing amplitude.
ANALOG: Representing data with physical quantities (a watch with hour and minute hands is an analog time display).
ANTENNA: any part of any SSB system that radiates radio energy.
ARQ: automatic repeat request; a mode to compare transmission; a repeat signal is sent only when requested by the receiving station.
BAND: a range of frequencies, usually within a one MHz span.
BANK: a collection of channels to be scanned as a group in order.
BINARY: A system of numbers represented only by digits 0 and 1. (Contrast with decimal which uses digits 0 through 9.)
CAPACITOR: A device to store electrical energy.
CARRIER: An unmodulated RF signal.

CHAN: Channel.

CHASSIS GND: Chassis or cabinet ground.

CLAR: Clarifier; allows receiver frequency to be offset slightly from transmitter frequency.

COMM: Communication; also used to reference serial communications computer port.

CW: Continuous wave; to transmit the mode of Morse code.

CRYSTAL: A piece of quartz mineral that will resonate at a particular frequency and used as a reference in transceivers.

COAX: An electrical conductor which carries radio energy from a transmitter to an antenna system; the inner conductor is insulated from an external wire mesh shield.

CHIP: A wafer of semiconductor material used in an electronic circuit.

COPY: When radio operators hear and write down a message, they "copy."

DATA I/O: Data input/output.

DC: Direct current.

DUPLEX: A method of frequency in which ship stations transmit on one frequency while shore stations transmit a different frequency

DSP: Digital signal processing; technology which eliminates unwanted noise to enhances a signal.

DXpedition: A contest in which amateur radio operators try to reach distant stations.

EMER: Emergency.

FEC: Forward error correction; a mode to compare transmission; each character is sent twice and the redundancy of the code serves as the check.

FEEDLINE: The method of connecting the antenna to the radio.

FREQUENCY: The number of polarity alternations per second measured in Hertz. KHz=thousand Hertz; MHz = million Hz.

FM: Frequency modulation.

FWD: Forward transmit power going to the antenna.

GAIN: The amount of amplification a system has; in antenna systems, the gain is the measurement of the directional characteristics.

GROUND: A connection to earth or an earth counterpoise.

GROUNDPLANE: An artificial ground used for antenna systems.

GROUNDWAVE: A radio signal that travels along the earth, bending over the horizon.

GMT: Greenwich Mean Time (universal time) the international standard time referred to the zero degree meridian.

HETERODYNE: The frequency that results when two radio frequencies "beat" together (one frequency minus the second frequency = heterodyne).

HERTZ: See Hz.

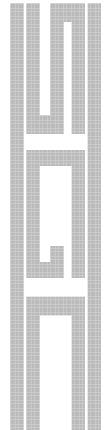

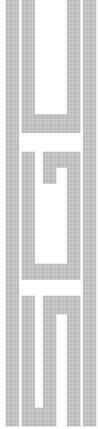

HF: A range of frequencies from 3 to 30 MHz.

Hz (Hertz): A measure of frequency: one cycle per second.

INDUCTOR: Electronic component that stores energy in a magnetic field, usually a coil.

IMPEDANCE: The apparent opposition in an electrical circuit to the flow of an alternating current.

IONOSPHERE: Electricity conducting layers in the earth's upper atmosphere.

KHz: 1000 Hertz.

LCD: Liquid crystal display.

LPA: Linear power amplifier.

LSB: Lower sideband.

LED: (Light-Emitting Diode) A semiconductor that lights up; used in digital displays.

MEMORY: A computer memory address to which channel information may be assigned.

MHz: 1 million Hertz.

MF: (Medium Frequency), a band of frequencies in the 2 MHz range used for short range communications.

MICROPROCESSOR: A computer processor contained on a chip.

MODULATION: The process of varying the amplitude, frequency or phase of a carrier or signal.

OSCILLATOR: A device that produces alternating current.

OSCILLOSCOPE: A display of frequency on a cathode ray tube.

PCB: Printed circuit board.

PHASE-SHIFT: Removing an unwanted frequency (or side band) by imposing a mirror-image frequency so the two cancel each other.

PTT: Push to talk.

PEP: Peak envelope power; commonly a power output rating.

PROPAGATION: The characteristics of different radio frequency transmissions, generally in regard to usable distance in relation to frequency and time of day.

RF: Radio frequency; any frequency higher than a person can hear.

RESONATE: The frequency that a circuit is tuned to

RADIATE: The movement of energy away from a place, as in the radiation of an antenna.

SSB: Single Side Band; a high efficiency type of radio transmission generally used for long distance communications where energy is not radiated until modulation is present.

SQL: Squelch.

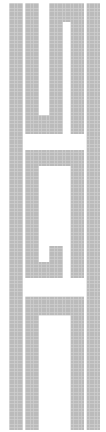

SIMPLEX: A method of frequency use in which stations transmit and receive on the same frequency.

SITOR: A commercial system of radio teletype for ship to shore, ship to ship and between ships and any telex subscriber; "ship international transmitting over radio."

SKIP: The bounce of the radio signal off the ionosphere.

SKYWAVE: A radio signal which is projected into the ionosphere and bounces one or more times before returning to earth.

SYNTHESIZER: The device that produces and controls frequencies through synthetic results.

SNS: Exclusive to SGC; spectral noise subtraction; works with DSP in signal processing to improve incoming signals.

TELEX: A commercial service involving teletypewriters connected through automatic exchange; "teleprinter + exchange."

TRANSCIVER: A term applied to equipment that both transmits and receives.

USB: Upper sideband.

UTC: Coordinated universal time; same as GMT.

VCO: Voltage controlled oscillator.

VHF: Very High Frequency; commonly refers to a short range type of radio whose signal is transmitted on a line of sight from antenna to antenna.

VSWR: Voltage standing wave ratio; a measurement of the efficiency of an antenna system; it measures the energy which is projected out and reflected back to the antenna.

VOLTAGE: A measurement of electrical pressure of the current times resistance.

VDC: Voltage direct current.

WAVELENGTH: Distance between two successive radio waves.

WORK: To be in radio contact or communication with another station.

XMT: Transmit.

XFMR: Transformer.

SMARTUNER® FAMILY

Smartuners for Stealth Antennas

The SGC series of Smartuners® are designed to be installed at the antenna feed point, thereby eliminating system loss caused by high VSWR on the feed line. The SGC Smartuner® is the heart of an all band, high performance antenna system. Fast automatic operation requires no operator intervention, and operates with any HF radio.

The SGC Smartuner® Family uses microprocessor control of a π (pi) or L network to match virtually any load to any transceiver. Their lightweight, slim design and universal mounting plate allow for quick and easy installation in any location. The weather proof design allows outdoor mounting, and gives the maximum possible multi-band performance from your antenna. The SGC Smartuners are backed by an industry leading 5 year warranty for your assurance. Add SGC brain power to your HF antenna system today!

Smartuner	Catalog #	Frequency Range	Power Output
SG-230	54-12	1.6 to 30 MHz	3 to 200 watts
SG-235	54-15	1.6 to 30 MHz	3 to 500 watts
SG-230PRO*	54-16	1.6 to 30 MHz	3 to 200 watts
SG-231	54-17	1 to 60 MHz	3 to 100 watts

* includes SmartLock Pro and RX preamplifier



The SGC Building
13737 S.E. 26th Street, Bellevue, Washington 98005, USA
Tel: 425-746-6310 • Fax 425-746-6384
E-mail SGCMKTG@aol.com
Web site: <http://www.sgeworld.com>

1-800-259-7331